

PLANT LIST

TREES					
KEY	QTY	BOTANICAL NAME	COMMON NAME	SIZE	SPACING/COMMENTS
	3	FRAXINUS PENNSYLVANICA 'PRAIRIE SPIRE'	PRAIRIE SPIRE GREEN ASH	6cm cal.	
	3	ACER PALMATUM 'SANGKO KAKU'	CORAL BARK JAPANESE MAPLE	2.5m ht.	

SHRUBS					
KEY	QTY	BOTANICAL NAME	COMMON NAME	SIZE	SPACING/COMMENTS
	60	BUXUS SEMPERVIRENS 'SUFFRUTICOSA'	EDGING BOXWOOD	# 3 pot	
	174	TAXUS x MEDIA 'HICKSI'	HICKSHI YEW	1.2m	
	30	AZALEA x HINDO-CRIMSON'	HINDO-CRIMSON AZALEA	# 2 pot	
	12	HYDRANGEA MACROPHYLLA 'BLUE BILLOWS'	LACECAP HYDRANGEA	# 5 pot	
	9	CHOISYA 'AZTEC PEARL'	MEXICAN MOCK ORANGE	# 3 pot	

GROUND COVER / PERENNIALS / FERNS / VINES / GRASSES					
KEY	QTY	BOTANICAL NAME	COMMON NAME	SIZE	SPACING/COMMENTS
	42	LAVANDULA ANGUSTIFOLIA	ENGLISH LAVENDER	# 1 pot	
	12	HOSTA 'JUNE'	JUNE HOSTA	# 1 pot	

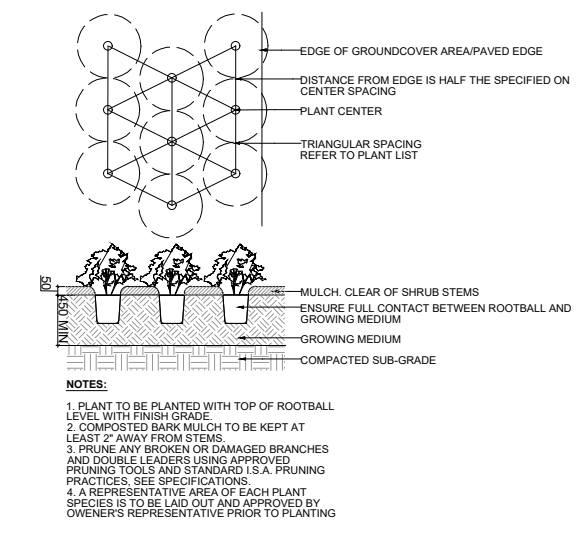

1 GROUNDCOVER PLANTING

SCALE: NTS

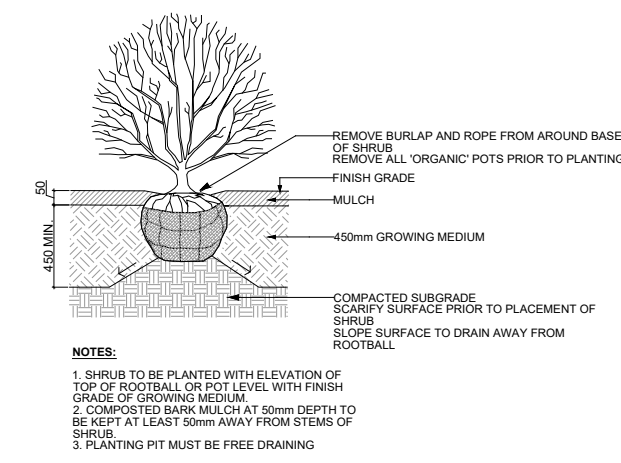

2 SHRUB PLANTING

SCALE: NTS

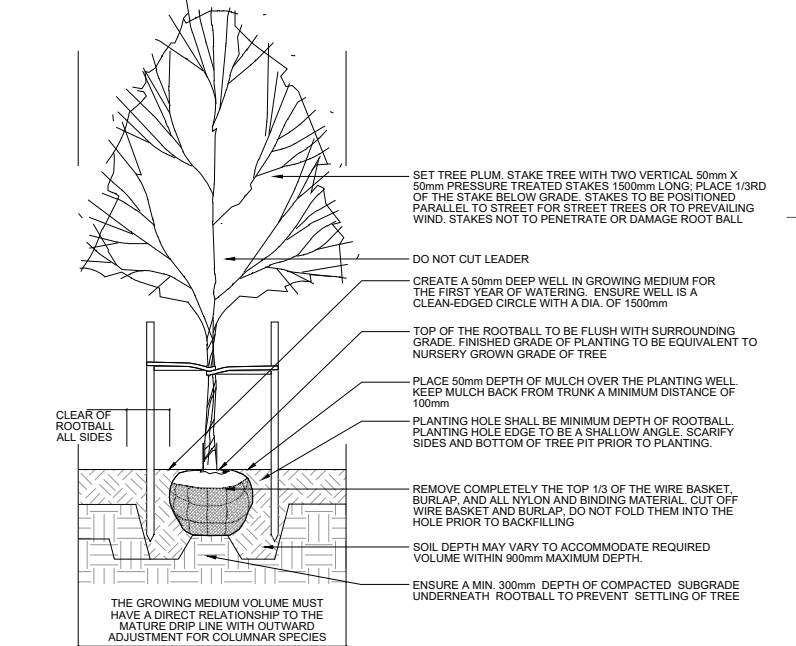

3 TREE PLANTING

SCALE: NTS

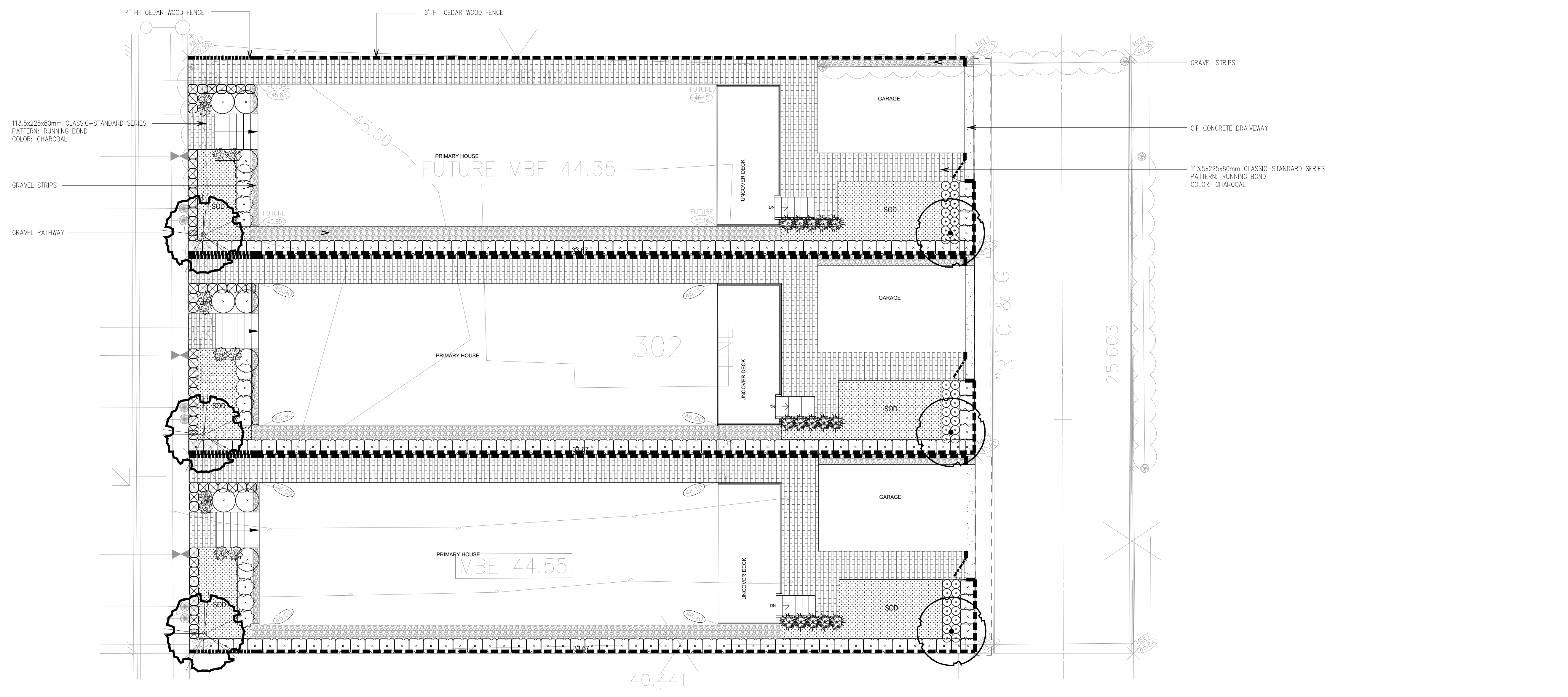

NO	DATE	DESCRIPTION
1	MAY 23, 2023	ISSUED FOR REVIEW

REVISIONS

PROJECT: **PROPOSED RESIDENTIAL**

12080 228 ST. MAPLE RIDGE, BC

SCALE: 1/8" = 1'-0"

DRAWN: EDJ

REVIEWED: FK

DRAWING: LANDSCAPE PLANTING PLAN

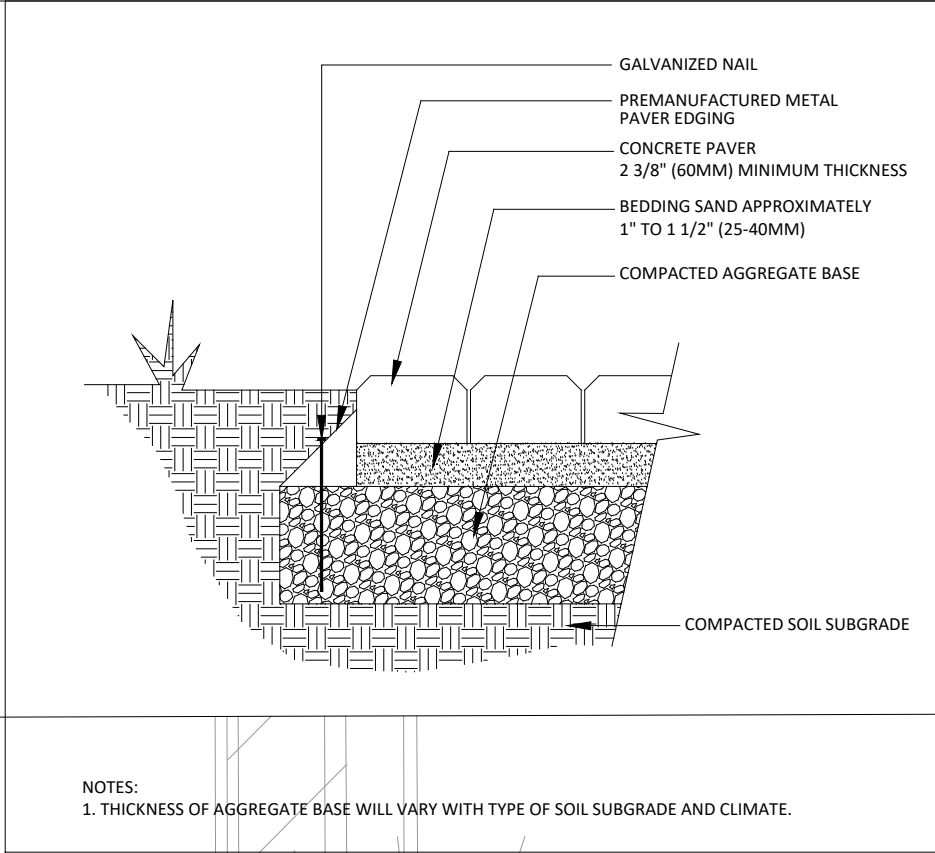
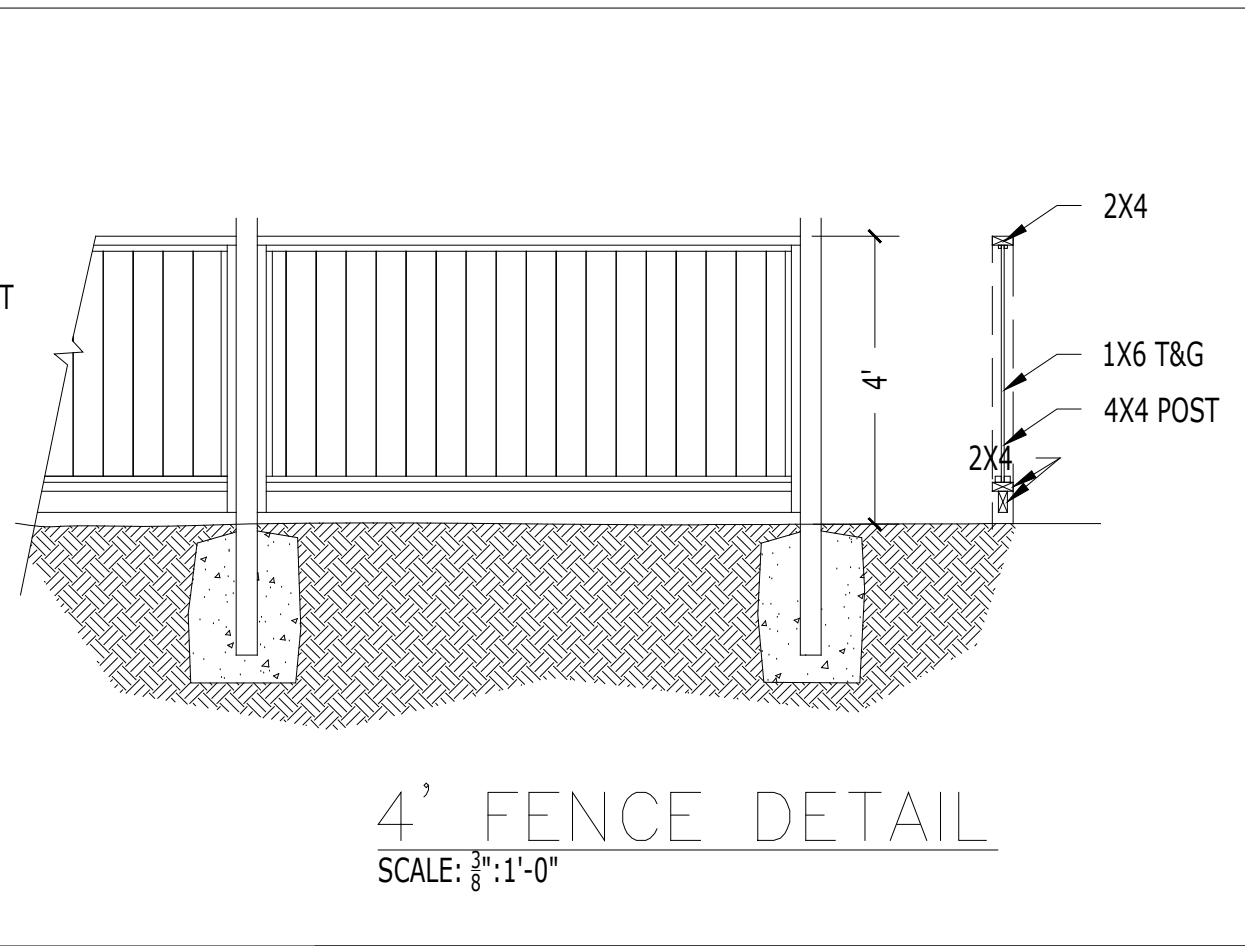
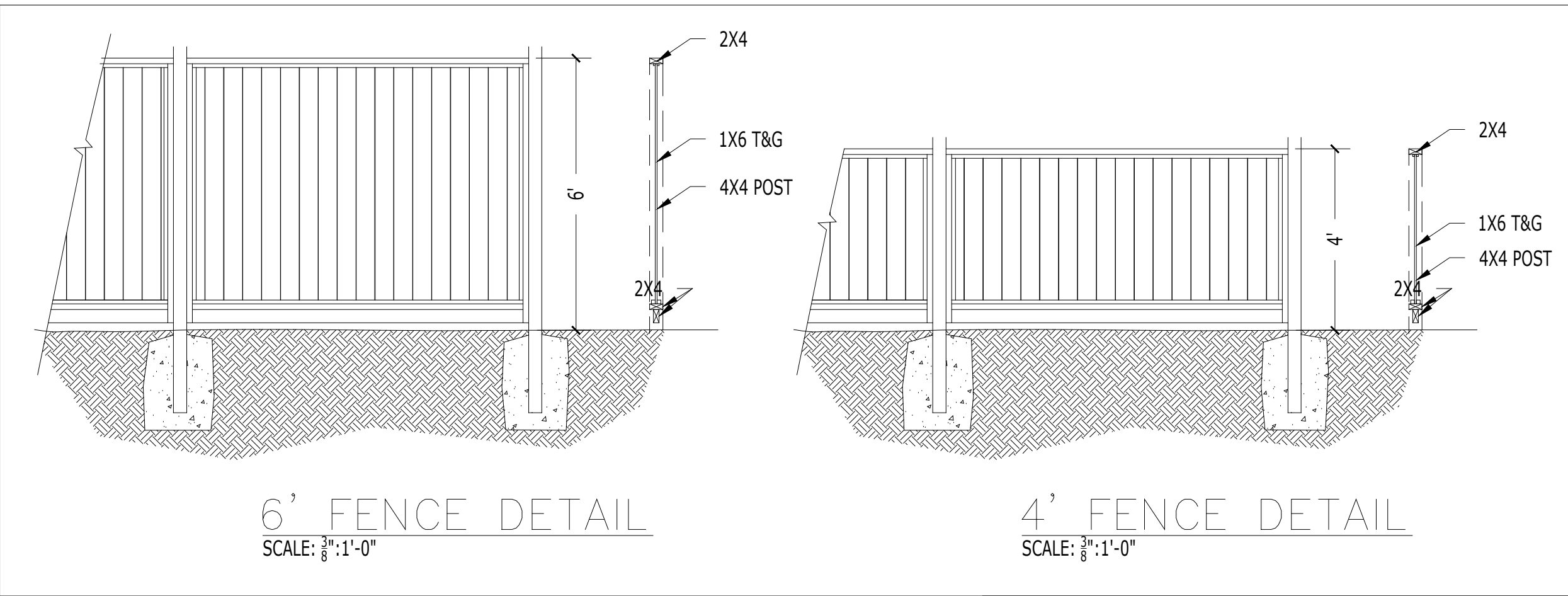
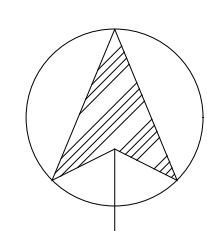

PLANT LIST

TREES					
KEY	QTY	BOTANICAL NAME	COMMON NAME	SIZE	SPACING/COMMENTS
	3	FRAXINUS PENNSYLVANICA 'PRAIRIE SPIRE'	PRAIRIE SPIRE GREEN ASH	6cm cal.	
	3	ACER PALMATUM 'SANGKO KAKU'	CORAL BARK JAPANESE MAPLE	2.5m ht.	

SHRUBS					
KEY	QTY	BOTANICAL NAME	COMMON NAME	SIZE	SPACING/COMMENTS
	51	BUXUS SEMPERVIRENS 'SUFFRUTICOSA'	EDGING BOXWOOD	# 3 pot	
	168	TAXUS x MEDIA 'HICKSI'	HICKSHI YEW	1.2m	
	9	AZALEA x 'HINO-CRIMSON'	HINO-CRIMSON AZALEA	# 2 pot	
	12	HYDRANGEA MACROPHYLLA 'BLUE BILLOWS'	LACECAP HYDRANGEA	# 3 pot	
	3	CHOISYA 'AZTEC PEARL'	MEXICAN MOCK ORANGE	# 3 pot	

GROUND COVER / PERENNIALS / FERNS / VINES / GRASSES

KEY	QTY	BOTANICAL NAME	COMMON NAME	SIZE	SPACING/COMMENTS
	30	LAVANDULA ANGSTUFIOLIA	ENGLISH LAVENDER	# 1 pot	
	6	HOSTA 'JUNE'	JUNE HOSTA	# 1 pot	

STREET TREE PLANT LIST

TREES					
KEY	QTY	BOTANICAL NAME	COMMON NAME	SIZE	SPACING/COMMENTS
	3	STYRAX JAPONICA	JAPANESE SNOWBELL	2.5m ht.	

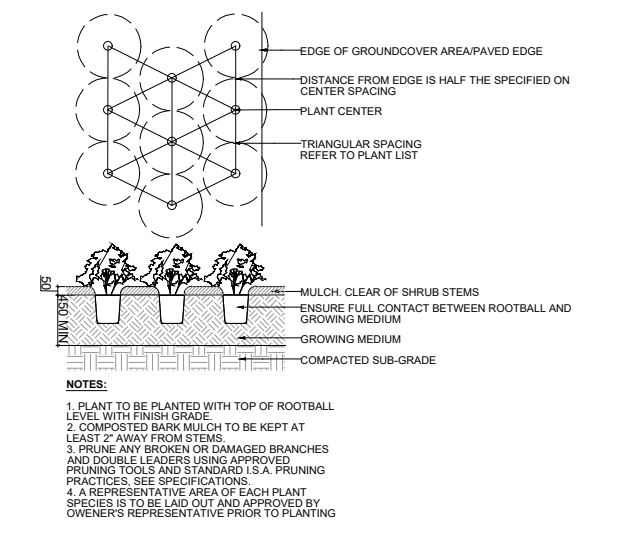

1 GROUND COVER PLANTING
 SCALE: NTS

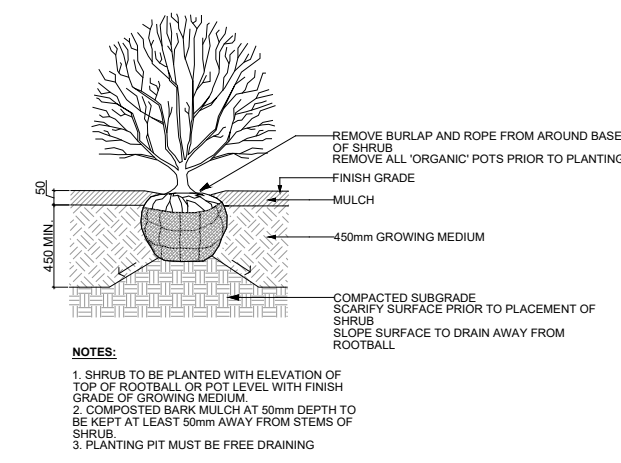

2 SHRUB PLANTING
 SCALE: NTS

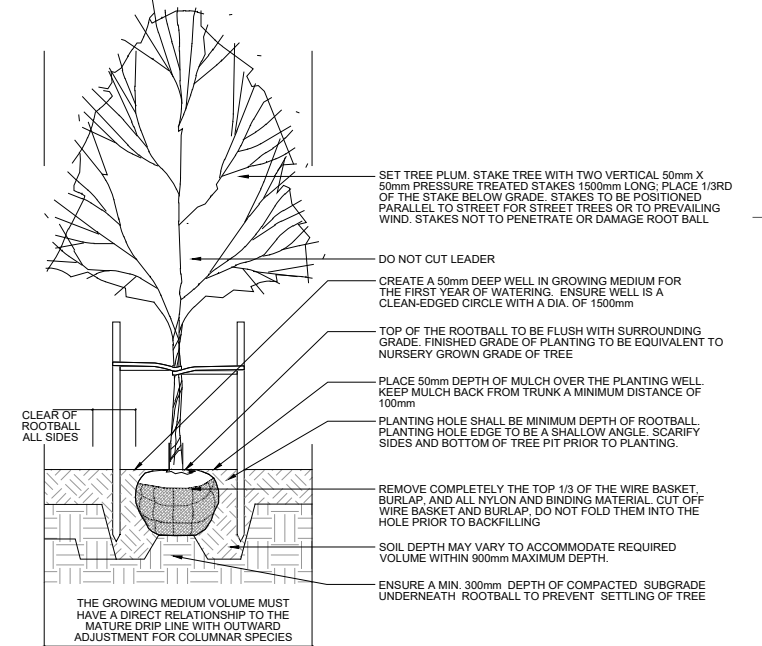

3 TREE PLANTING
 SCALE: NTS

NOTES:
 1. THICKNESS OF AGGREGATE BASE WILL VARY WITH TYPE OF SOIL SUBGRADE AND CLIMATE.

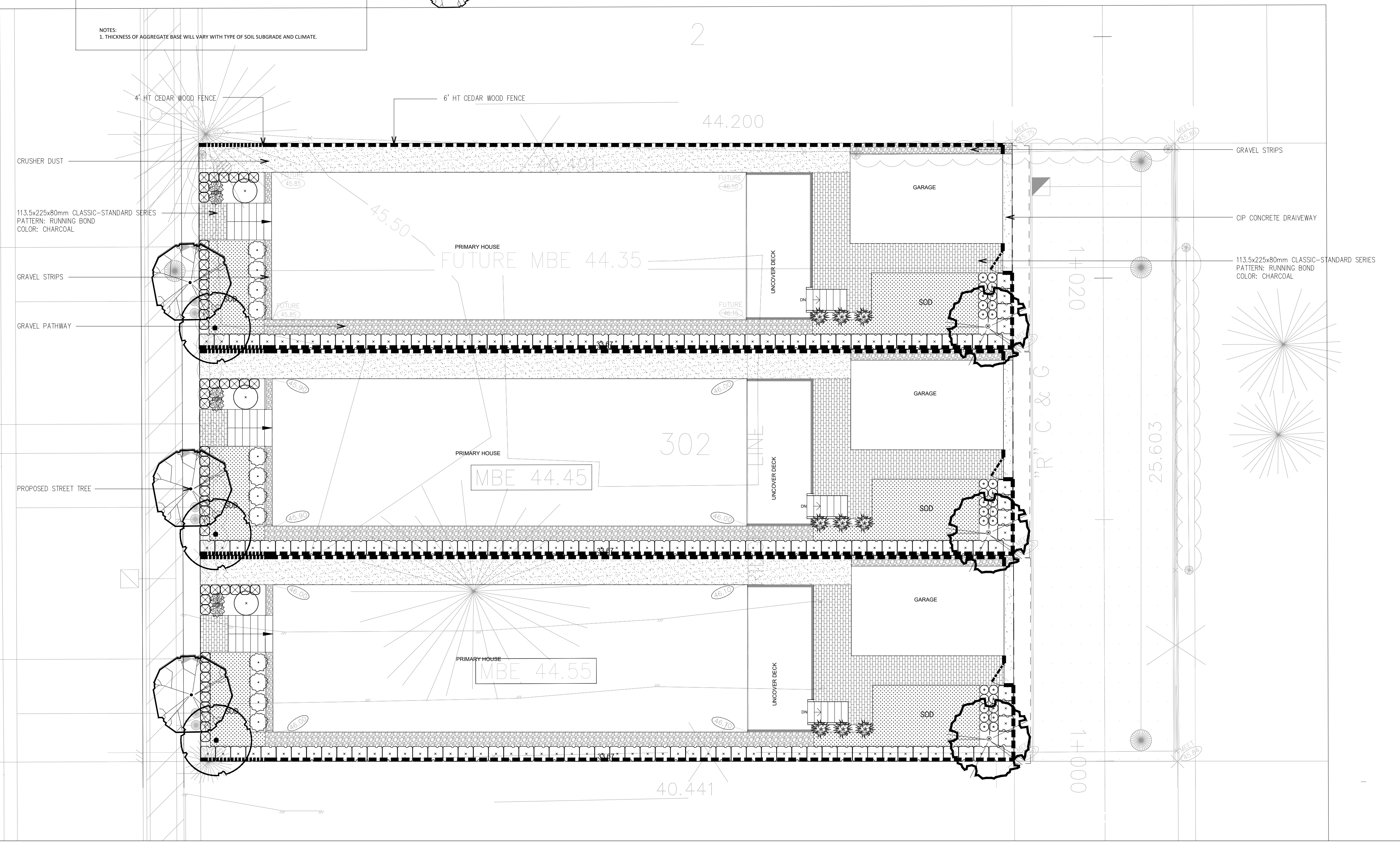

NO	DATE	DESCRIPTION
3	AUG 24, 2023	REVISED AS PER COMMENTS
2	JUN 19, 2023	REVISED AS PER COMMENTS
1	MAY 23, 2023	ISSUED FOR REVIEW

REVISIONS
 PROJECT: **PROPOSED RESIDENTIAL**

12080 228 ST. MAPLE RIDGE, BC
 SCALE: 1/8" = 1'-0"
 DRAWN: EDJ
 REVIEWED: FK

DRAWING: **LANDSCAPE PLANTING PLAN**